

Goodmans

HD Digital Box
GFSAT200HD/A



Instruction Manual



Welcome

Thank you for choosing this Goodmans freesat HD Digital Box.

Not only can it receive over 140 subscription free channels, but if you have a broadband service with a minimum speed of 1Mb you can access IP TV services, which you can watch back at a time to suit you.

It's really simple to use; it's all done using the clear, easy to understand on screen menus which are operated from the remote control. It even has a reminder function so that you won't miss your favourite programmes.



For a one off payment, you can buy a digital box, satellite dish and installation giving you over 140 channels covering the best of TV and more.



A digital box lets you access digital channels that are broadcast in the UK. It uses a digital signal, received through your satellite dish and lets you watch it through your existing television.



This product is capable of receiving and decoding Dolby Digital Plus.

Manufactured under license from Dolby Laboratories. Dolby and the double-D symbol are trademarks of Dolby Laboratories.



This product has a HDMI connector so that you can watch high definition TV via a HDMI lead when connected to a HD Ready TV.

HDMI, the HDMI logo and High-Definition Multimedia Interface are trademarks or registered trademarks of HDMI Licensing LLC.

The illustrations and screen shots shown in this instruction manual are for reference and instruction purposes only, and may not exactly match the product.

What's in the box?

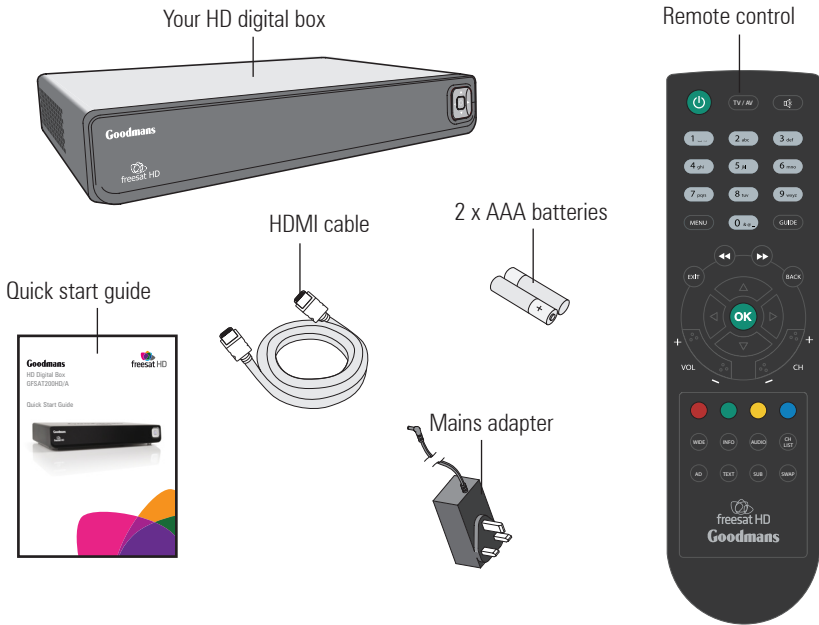

Contents

01	Your HD digital box.....	4	09	System information.....	18
02	Your remote control.....	5	10	Non-freesat channels.....	19
03	Connecting up.....	6	11	Help and advice.....	20
04	Get started.....	7	12	Safety.....	23
05	Daily use.....	8	13	Technical specification.....	24
06	The guide window.....	10	14	Guarantee.....	25
07	The channel list.....	12			
08	The settings menu.....	14			

Front view

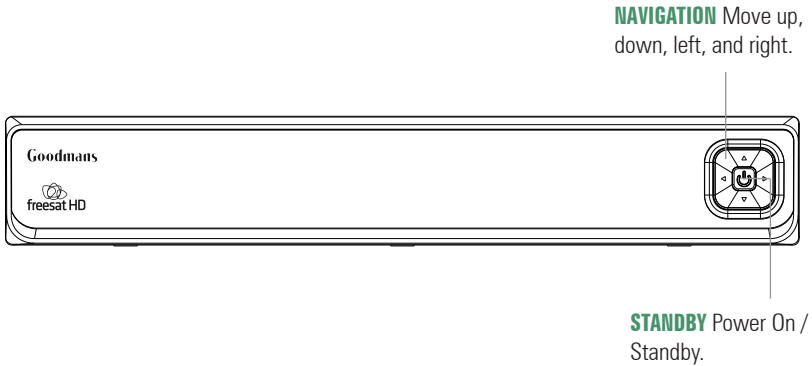

Rear view

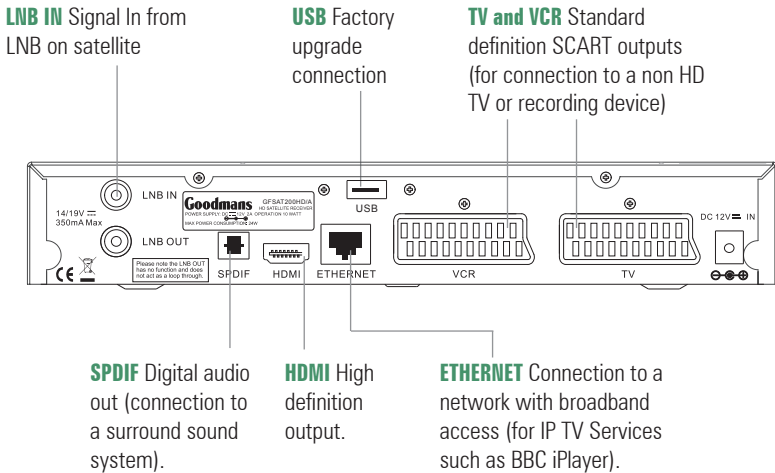

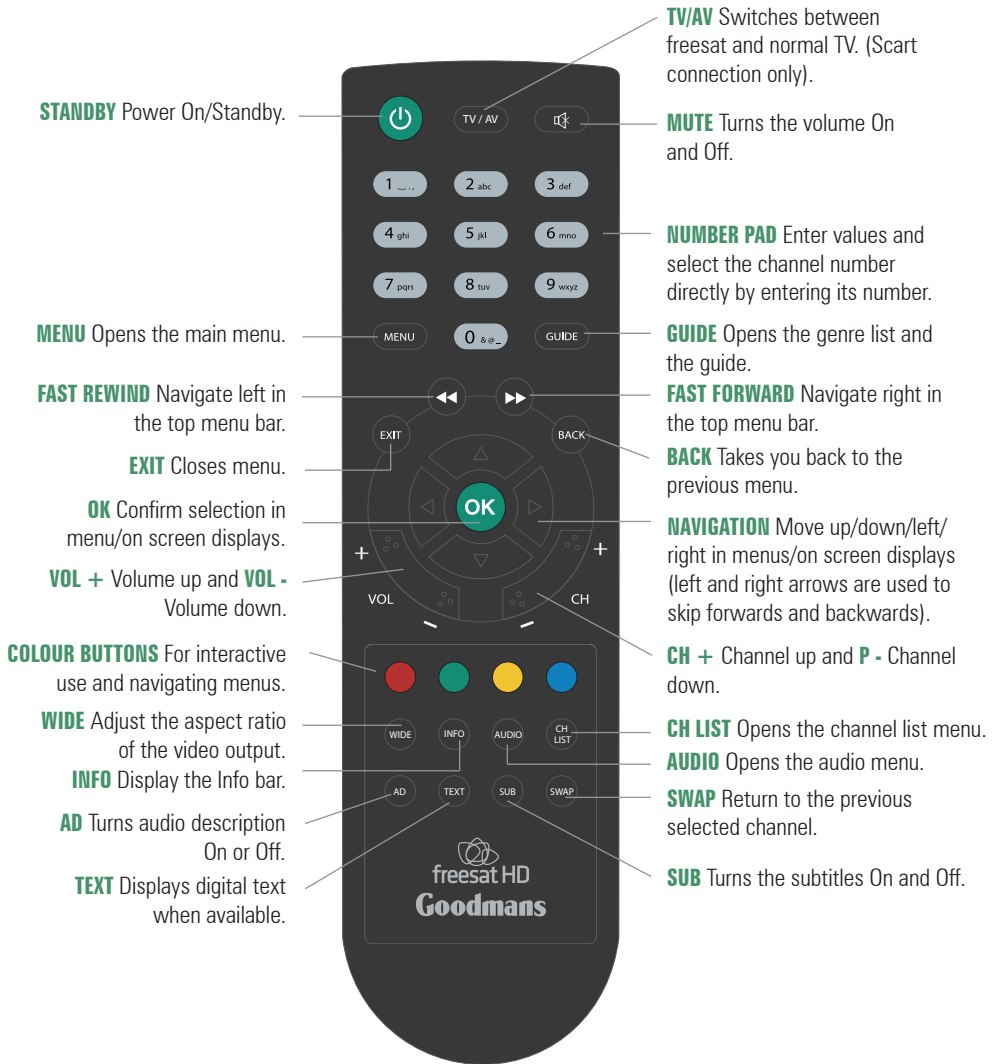

Getting connected

Connecting to a HD Ready TV

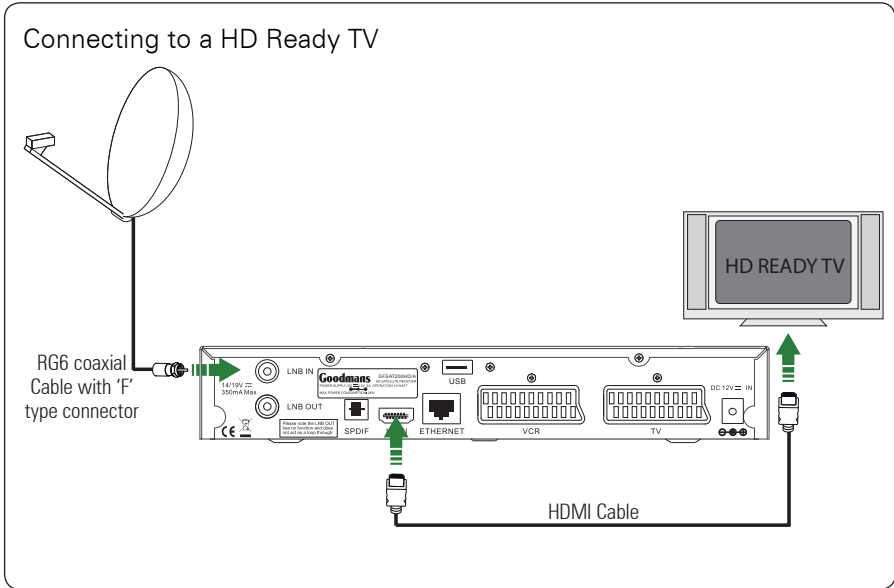

Connect a RG6 co-axial cable fitted with 'F' a type connector from your satellite dish to the 'LNB IN' socket on the back panel of your digital box.

Connect the HDMI cable that came with your digital box between the 'HDMI' socket on the back panel of your digital box and a HDMI socket on your TV.

Other connections

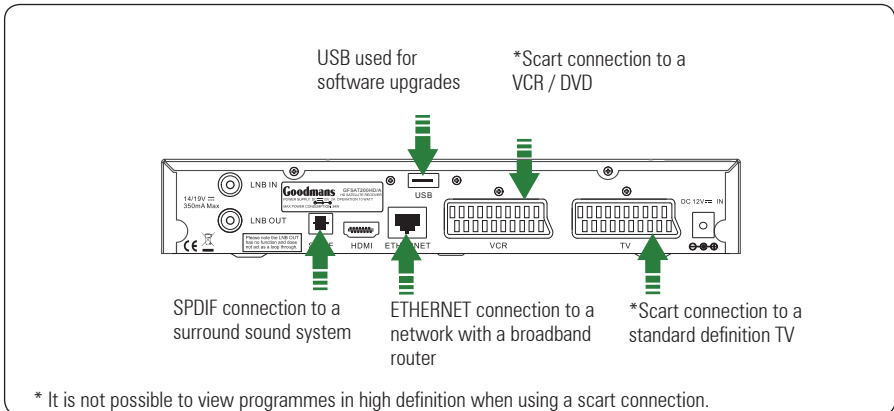

1

Put batteries in the remote control

Open the battery cover of the remote control and put two AAA size batteries so that the '+' and '-' marks on the batteries match the '+' and '-' marks inside the remote control. Replace the battery cover.

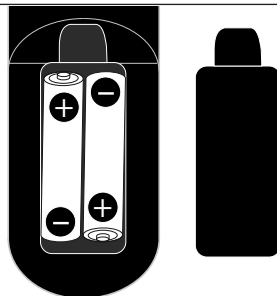

2

Plug in and switch on

Insert the mains lead into the '12V DC IN' on the back of the digital box. The standby light on the front of the digital box will come on.

Switch your TV On and select HDMI.

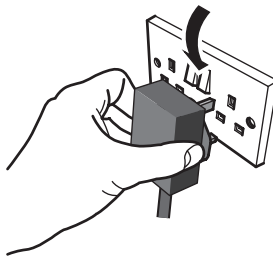

3

The first time install screen

The first time installation screen will appear on screen.

If the signal strength is above 50% press the **[OK]** button on your remote control to continue the setup.

Follow the instructions on screen to complete the installation.

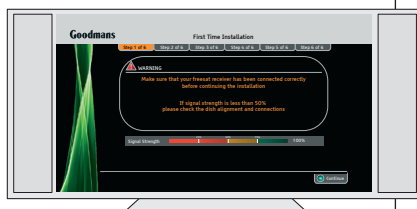

We have divided this book into separate sections, so that you can find the information you're looking for easier. This section covers the day-to-day functions that you will use most often.

Choosing a programme

Press the **[GUIDE]** button on the remote control to open the Genre front page.

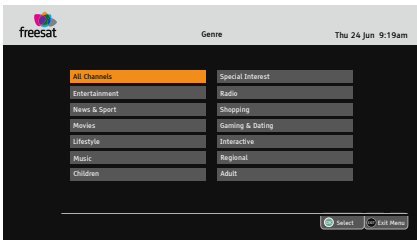

Use the arrow buttons to select a genre and then press the **[OK]** button.

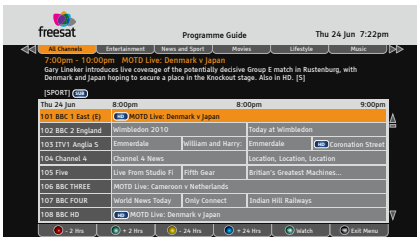

Use the **[▲]** and **[▼]** buttons to select different channels. If you want to choose a new genre press the **[◀◀]** or **[▶▶]** buttons to select a new genre category. When you have chosen your programme, press the **[OK]** button to watch it.

Changing the channel

You can also select the channel you want to watch by using the **[P+]** and **[P-]** buttons on the remote control. Alternatively you can use the number buttons to key in the channel number.

When you change the channel the information screen will be displayed for a few seconds.

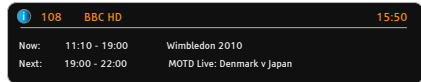

This shows the details of the programme currently showing and the next programme.

The information bar

If you want to see information about the programme you are watching, you can press the **[i]** button.

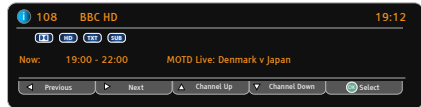

Use the **[▲]** and **[▼]** buttons to select different channels, and the **[◀]** and **[▶]** buttons to view the now and next programmes.

If you want to see more information press the **[i]** button again.

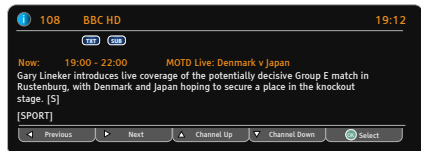

Changing the volume

You can change the volume using the [VOL+] and [VOL-] buttons on the remote control. You can turn off the volume pressing the [MUTE] button. To turn it back on press the [MUTE] button again.

Audio description

Audio description is an additional narration that describes all significant visual information such as body language, facial expression, scenery, costumes - anything that is important to the plot of the story, event or image.

Press the [AD] button to toggle this setting on and off.

Audio channel

Sometimes different audio languages are available with certain programmes or channels.

Press the [AUDIO] button to see the available languages.

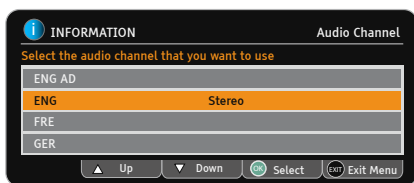

Use the [▲] and [▼] buttons to select a different audio channel. Press the [OK] button to confirm the setting.

DON'T FORGET! Audio description has 'AD' next to the language. Not all programmes have audio description or additional audio channels available.

Subtitles

Press the [SUB] button to toggle the subtitles on and off.

DON'T FORGET! Not all programmes have subtitles. You can use the information bar to see if the blue 'SUB' icon is shown.

Red button services

Some channels offer additional services via the red button on your remote control. When additional services are available a red dot will be shown in the top right hand part of your TV screen.

Press the red button to open the menu. An example screen is shown below.



DON'T FORGET! You may get different options available to you if your digital box is connected to your network and broadband router.

The guide window

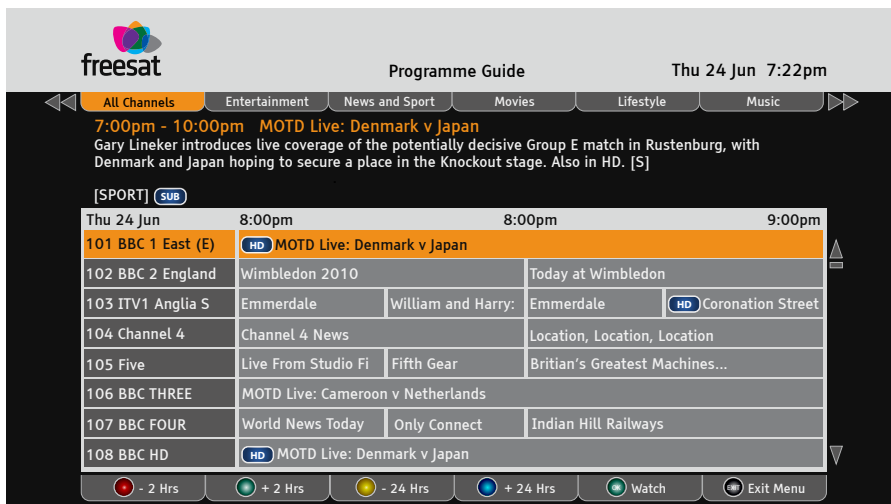

Navigation

You can open the guide window by pressing the **[GUIDE]** button on the remote control. The guide shows you all of the programmes and channels available for the next 8 days.

Use the **[▲]** and **[▼]** buttons to select different channels. You can use the **[P+]** and **[P-]** buttons to move a page at a time.

The **[RED]** button will move backwards 2 hours, the **[GREEN]** button will move forwards 2 hours, the **[YELLOW]** button will move backwards 24 hours and the **[BLUE]** button will move forwards 24 hours.

If you want to choose a new genre while your in the guide, press the **[◀◀]** or **[▶▶]** buttons to select a new genre category.

When you have chosen your programme, press the **[OK]** button to watch it.

Guide icons

	This programme has audio description.
	This programme is broadcast with Dolby Digital.
	This programme is broadcast with Dolby Digital Plus.
	This programme contains guidance information.
	This programme is broadcast in high definition.
	This programme has been set as a reminder.
	This programme has subtitles.
	This programme has digital text available.

Setting a reminder

You can use the reminder function to let you know when a programme is going to start.



Use the [▲], [▼], [◀] and [▶] buttons to select a programme.

Press the [OK] button to set the reminder. When the reminder has been set a clock icon is shown before the programme name.

DON'T FORGET! To cancel a programme reminder, highlight the programme where the reminder has been set, and press the [OK] button. The clock icon will disappear and the reminder will be cancelled.

Reminder clash

If you try to set a reminder for more than two programmes at the same time, you will see a warning screen with a list of options for you to choose. An example screen is shown below;

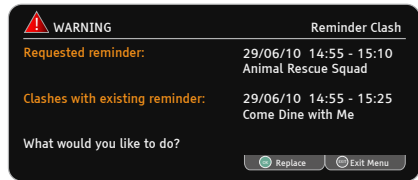

To replace the reminder with the new programme press the [OK] button, or to cancel the new reminder and keep the old reminder press the [EXIT] button.

The channel List

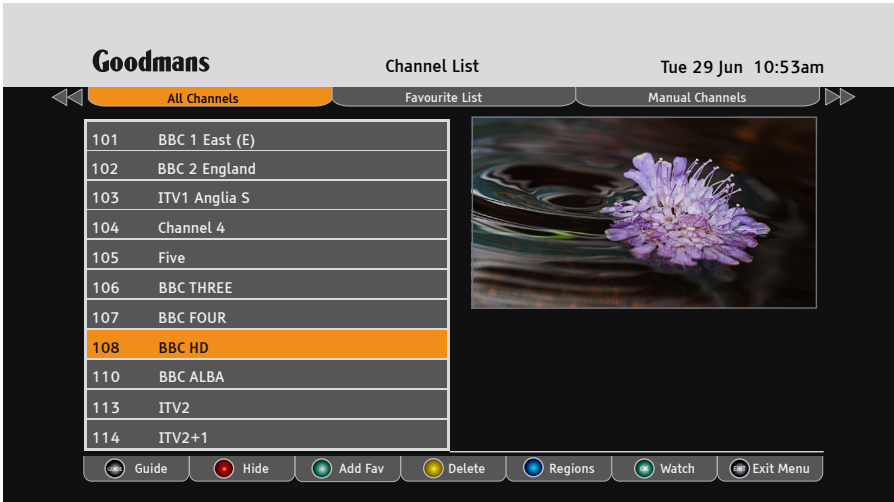

You can open the channel list window by pressing the **[CH LIST]** button on the remote control or from the main menu.

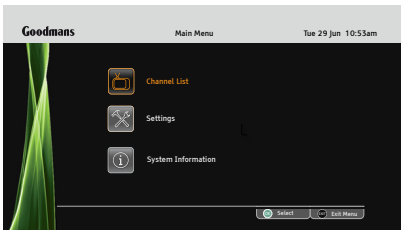

This channel list allows you to hide, and delete channels, setup a favourites channel list, setup a manual recording and view the list of free to air channels that you have added.

DON'T FORGET! See page 19 for further information on how to add free to air channels.

Use the **[◀◀]** or **[▶▶]** buttons to switch between 'All Channels', 'Favourite List' and 'Manual Channels'.

Channel list icons

	Opens the Guide window.
	This will hide the channel from the Guide window.
	Adds the channel to your favourite list.
	This will permanently delete the current channel.
	This allows you to change the channel to a different region.
	This channel has been hidden from the Guide window.

The channel List

Hiding a channel

Use the [▲] and [▼] buttons to select the channel that you want to hide. Press the [RED] button to hide it.

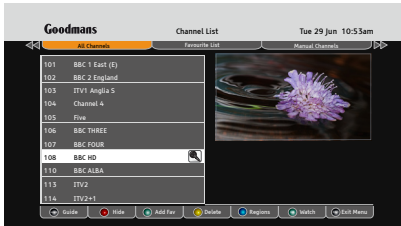

When a channel is hidden, a magnifying glass icon will be shown.

To unlock a channel, select the hidden channel using the [▲] and [▼] buttons. Press the [RED] button to unhide it.

DON'T FORGET! Hidden channels will not be shown in the Programme Guide window.

Favourites

The favourites function lets you keep your favourite channels in a separate list.

Use the [▲] and [▼] buttons to select a channel. Press the [GREEN] button to add it to the favourite list.

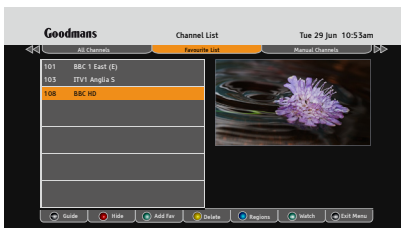

To add additional channels to your favourites list press the [◀◀] button and select a new channel.

Deleting a channel

Use the [▲] and [▼] buttons to select a channel that you want to delete. Press the [YELLOW] button to delete it.

DON'T FORGET! It is not possible to un-delete a channel. You will have to do a First Time Install again. See page 17.

Changing the region

Some channels have different regions available. You can swap them with the default channel that was assigned when you completed the first time installation. Select a channel that has a different region using the [▲] and [▼] buttons then press the [BLUE] button.

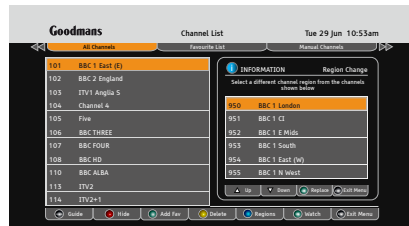

Select a new region from the right hand column, and press the [OK] button to swap it.

Manual Channels

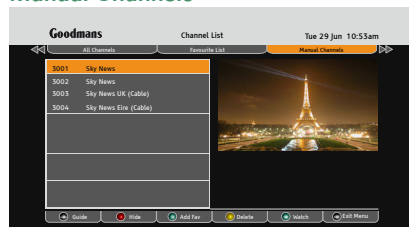

The manual channel tab shows you your non-freesat channels. See page 19 for further information about how to add non-freesat channels to your channel list.

The settings menu

To open the settings menu press the [MENU] button on the remote control and then select 'Settings'.

Press the [OK] button to confirm.

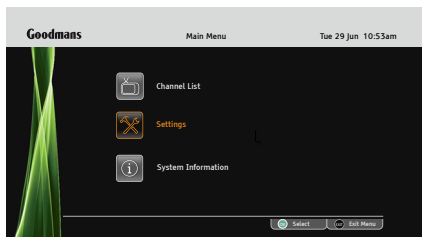

Changing the settings

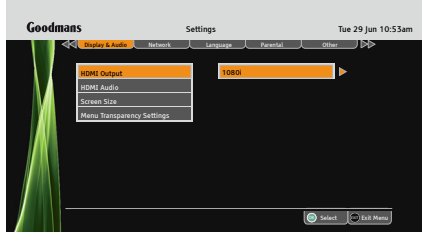

Use the [▲] and [▼] buttons to select each option.

If you want to change the setting press the [◀] or [▶] buttons. Press the [OK] button to save the setting.

If you want to view a different settings category press the [◀◀] or [▶▶] buttons.

To close any of the settings screens, press the [EXIT] button.

Display and audio

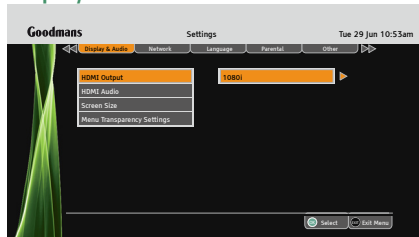

HDMI Output - You can change this setting to best match your HD Ready TV. You can choose between 576p, 720p, and 1080i.

HDMI Audio - If your digital box is connected to your surround sound system using HDMI, choose the 'Dolby Digital' setting. If your digital box is connected to your surround sound system using the SPDIF connection use the 'Stereo Downmix' setting.

Screen Size - You will have already set this up as part of the installation process, but you can change the format of the screen size here without having to install your digital box again. You can choose between 16:9 widescreen, 4:3 widescreen, 4:3 centre cut out, and 4:3 letter box.

DON'T FORGET! Not all programmes are broadcast in widescreen format which may result in a black border around the programme. This setting can be useful to remove or minimise the border.

Menu Transparency - This setting allows you to adjust how see through the menus are. By adjusting the setting you will be able to see the programme behind the on screen menu. The default setting is off.

The settings menu

Network

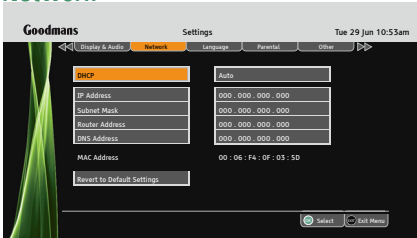

DON'T FORGET! Before setting up this network window you should connect your freesat digital box to your home network. For instructions on connecting your box and using the BBC iPlayer service go to www.freesat.co.uk/iplayer

DHCP - This stands for 'Dynamic Host Configuration Protocol'. If DHCP is set to Auto your freesat digital box will be set up automatically when connected to your home network. If you choose the manual setting you will need to manually set the next options.

IP Address - This is the unique IP address number of your freesat digital box. Each item on your network will have it's own IP address. An example IP address will look something like 192.168.1.0

Subnet Mask - This is used to split large networks into smaller sub groups to stop excessive data from being transmitted along a network. Each network group will have it's own subnet mask ID. A subnet mask number will look like 255.255.255.0.

Router Address - This is the IP address of your broadband router.

DNS Address - This stands for 'Domain Name System'. Your DNS address will have been assigned to you by your internet provider.

MAC Address - The MAC address is a unique number that is embedded into your freesat digital box that allows you to connect to online services. It is not possible to change your MAC address number.

Revert to Default Settings - This setting will put your network settings page back to it's original state.

Language

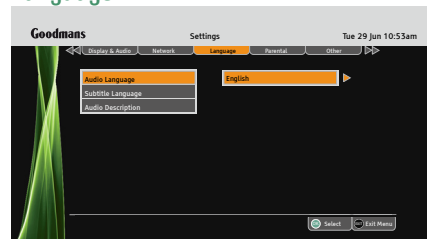

Audio Language - This setting is your preferred default audio language. The options are English, Welsh, Gaelic, and Irish Gaelic.

Subtitle Language - This setting is your preferred default subtitle language. The options are English, Welsh, Gaelic, and Irish Gaelic.

DON'T FORGET! Not all programmes have these languages available. If you preferred setting is not available, English language will be used instead.

Audio description - This is an additional narration that describes all significant visual information such as body language, facial expression, scenery, costumes - anything that is important to the plot of the story, event or image. You can turn on and off audio description here.

DON'T FORGET! You can toggle audio description on and off by pressing the **[AD]** button on the remote control.

The settings menu

Parental

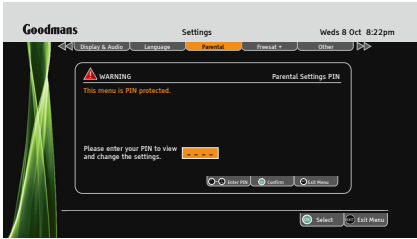

When the Parental menu is selected, you need to enter your system PIN to see the settings.

DON'T FORGET! You will have set your system PIN when installing your digital box. If you can't remember your system PIN please contact our helpline.

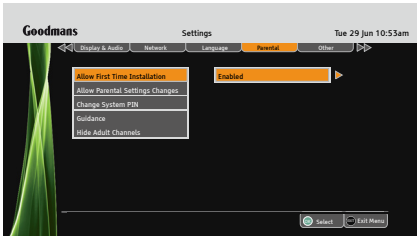

Allow First Time Installation - This setting chooses if you want to allow a first time installation.

DON'T FORGET! A first time installation will remove all non freesat channels.

Allow Parental Settings Changes - This setting chooses if you want to allow access to the parental menu without entering your system PIN. The default setting is that you must enter a PIN.

Change System PIN - This setting allows you to change the system PIN.

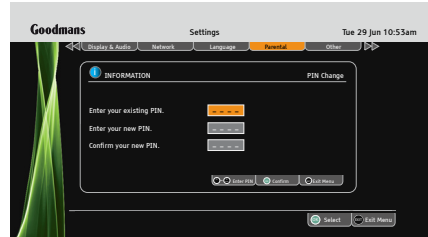

Guidance - This setting is used when you are viewing IP TV services such as BBC iPlayer. There are three different options available;

PIN on - all IP TV guidance content - This will require you to enter your system PIN if a programme contains guidance information. This is the default setting.

PIN on - all IP TV content - This will require you to enter a PIN for every programme that you want to watch even if it does not contain any guidance information.

PIN off - all IP TV content - This setting will not ask you to enter a PIN for any programme, even if it contains guidance information.

Hide Adult Genre - This setting chooses if you want to allow access to channels in the Adult genre category. The default setting is that adult channels are displayed in the channel list and programme guide.

Other

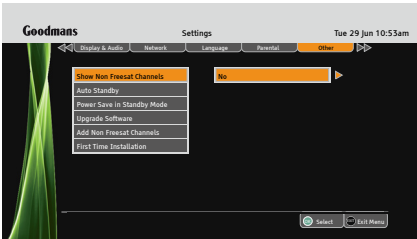

Show Non Freesat Channels - This setting allows you to see the manually added free to air channels in the channel list.

DON'T FORGET! The default setting is not to show manually added free to air channels. Free to air channels are not added to the programme guide.

Auto Standby - This will put the digital box into standby if there has been no user activity for four hours. A thirty second countdown is shown on screen, to give the user the option to cancel going into standby.

Power Save in Standby Mode - This setting reduces the amount of energy used when in standby mode.

Add Non Freesat Channels - See page 19 for further instructions.

First Time Installation - This setting allows you to perform a first time installation. Follow the instructions on-screen to setup your digital box.

DON'T FORGET! A first time installation will remove all non freesat channels.

System information

To open the system information window press the **[MENU]** button on the remote control and then select 'System Information'.

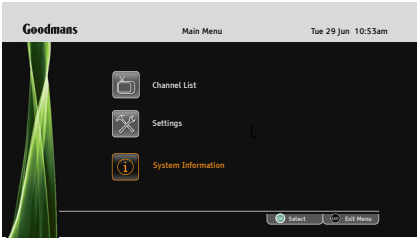

Press the **[OK]** button to confirm.

DON'T FORGET! It is useful to have access to the system information screen when contacting the call centre

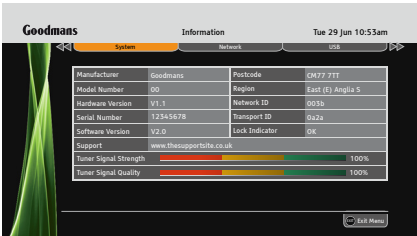

If you want to view a different information category press the **[◀◀]** or **[▶▶]** buttons.

To close any of the settings screens, press the **[EXIT]** button.

Non-freesat channels

You can manually tune in any free to air channels on your digital box, if you have the frequency in MHz, the symbol rate and the LNB polarisation.

DON'T FORGET! Adding free to air channels will not affect the stored freesat channels. Details of channel frequencies are generally available online, and are subject to change.

Open 'Add Non-freesat Channels' from the settings menu.

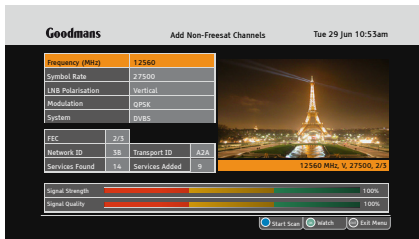

Use the [▲] and [▼] buttons to select each option.

If you want to change the setting press the [◀] or [▶] buttons, or key in the setting using the number buttons.

Press the [BLUE] button to search for additional channels.

Once the search is complete, any new channels will be available from the channel list.

DON'T FORGET! To view non-freesat channels, you must select 'yes' in the 'Show Non Freesat Channels' setting. Non-freesat channels are only available from the Channel List and are not shown in the Programme Guide.

To view the non-freesat channels press the [CH LIST] button, and press the [◀◀] or [▶▶] buttons to highlight Manual Channels.



Use the [▲] and [▼] buttons to select a channel and press the [OK] button to watch it.

Frequently asked questions	What you can do
In which direction should my satellite dish be positioned?	Your satellite dish should be fitted on a south facing wall in the direction of 28.2 ° east of south.
Can I connect more than one digital box to my satellite dish?	Yes you can. You will need an LNB (the box on your satellite dish) fitted that has more than one connection.
Can I connect this digital box to my normal roof aerial?	No. This box must be connected to a satellite dish for it to work.
The digital box will not switch on. What should I do?	Check the mains power cable and make sure it is plugged into a suitable power outlet. Check that the mains supply is switched On. Connect the power cable to a different power outlet.
My digital box can't find the 'Network ID' and 'Transport ID' what should I do?	Make sure that your satellite dish is positioned correctly, and check the cables and connections again.
Why do I have to enter my postcode in the first time set-up?	This makes sure that you receive programmes for your local region.
How do I enter a space when entering the postcode?	Your digital box will automatically enter the space for you. Enter your full postcode using the number buttons and then press the 'OK' button.
How do I do a first-time installation again?	You can do a first-time installation again using the settings menu. See page 17 for more information.
I'm not getting a picture on the TV. What should I do?	<ul style="list-style-type: none"> • Make sure that the digital box is On. (Press the 'STANDBY' button.) • Make sure that the HDMI or SCART cable is firmly connected to the TV. • Check the brightness level of the TV.
Can I receive high-definition programmes with this digital box?	Yes. You can receive high-definition programmes with this digital box.

Frequently asked questions	What you can do
Can I change the audio language for the programme I am watching?	Yes. Some channels broadcast other audio languages. Press the [AUDIO] button when you are watching a programme to see if other languages are available.
Do I have to retune my digital box when digital switchover happens in my region?	No. All freesat receivers do not have to be retuned as it receives its signal from a satellite and not an aerial.
Do I have to retune my digital box when new channels are added?	No. Your digital box will automatically add new freesat channels for you, and display them in the programme guide and channel list.
Can I use 'red button' interactive services with this digital box?	Yes. Some channels offer interactive services such as news, sport and weather. When interactive services are available, a red dot will appear in the top right-hand side of the screen. Simply press the red button on your remote control to access them.
Can I add 'FTA (Free To Air)' channels to my digital box?	Yes. You can add these using the 'Add Non-Freesat Channels' menu. See page 19 for more information.
Why can't I see my FTA channels?	Free to Air channels are not shown in the TV programme guide. Make sure that 'Show Non-Freesat Channels' is set to 'yes'. Press the [CH LIST] button to see them. See page 19 for more information.
How can I find out system information about my digital box?	Press the 'MENU' button and select 'System Information'.

Frequently asked questions	What you can do
My picture and sound quality is poor. What should I do?	<ul style="list-style-type: none"> • Make sure there are no mobile phones, DECT phones, wireless routers or microwave ovens near the receiver. • Keep the power and the satellite cable apart from each other. • Check the signal levels using the system information screen. The signal level may be affected by weather conditions. If the LNB is covered with snow or there is heavy rain, the sound and picture quality may be poor temporarily.
How do I connect my digital box to the internet so that I can use services like BBC iPlayer?	For the latest information about BBC iPlayer and how to setup and connect your digital box, go to www.freesat.co.uk/iplayer .
Where can I find out more about freesat?	For the latest news and information go to channel 999 on your digital box, or go to www.freesat.co.uk

Need extra information or help setting up?

You may find the information you are looking for on our web site.

www.thesupportsite.co.uk

or on the freesat website

www.freesat.co.uk

If you still need help or information you can phone our call centre on:

0871 230 4695

Calls are charged at 10p per minute when called from a BT land line. Call charges may vary if using other networks.

General Safety

This equipment has been designed and manufactured to meet European safety standards, but like any electrical equipment, care must be taken if you are to obtain the best results and safety is to be assured.

Do read these operating instructions before you attempt to use the equipment.

Do ensure that all electrical connections (including the mains adapter, extension leads and interconnections between pieces of equipment) are properly made in accordance with the manufacturer's instructions.

Switch off and remove the mains adapter when making or changing any connections.

Do consult your dealer if you are ever in doubt about the installation, operation or safety of your equipment.

Don't continue to operate the equipment if you are ever in doubt about it working normally, or if it is damaged in any way. Switch it off withdraw the adapter from the mains and consult your dealer.

Don't remove any fixed covers as this may expose you to dangerous voltages.

Make sure that other people in your household are conversant with the equipment.

Don't obstruct the ventilation vents on the equipment, for example with curtains or soft furnishings.

Overheating will cause damage and shorten the life of the product.

Don't allow electrical equipment to be exposed to rain or moisture.

General Information:	
Model number	GFSAT200HD/A
Tuner type	Single DVB S2
HDMI output options	576p, 720p, 1080i
Power Information:	
Input voltage	DC 12V 2A
Power consumption	Max 24W
Operating power consumption	10W
Features:	
Access all freesat digital channels and radio stations.	
Upscaling of standard definition TV to 1080i when using the HDMI connection.	
8 Day electronic programme guide.	
Audio description capable (broadcast mix).	
Digital text (MHEG5).	
Menu transparency.	
Parental control.	
Ethernet port for connection to IP TV services.	
Receive free to air (FTA) channels.	
Twin Scart.	
HDMI connection.	
Auto standby.	

The digital box is guaranteed for twelve months from the date of original purchase. If any defect due to faulty materials or workmanship, contact the Goodmans Helpline. Have your receipt of purchase available for reference.

The guarantee is subject to the following provisions:

- It is only valid within the boundaries of the country of purchase.
- The digital box must be correctly installed and operated in accordance with the instructions contained in this instruction manual.
- The digital box must be used solely for domestic purposes.
- The guarantee will be rendered invalid if the digital box is re-sold or has been damaged by inexpert repair.
- The manufacturer disclaims any liability for incidental or consequential damages.
- The guarantee is in addition to, and does not diminish, your statutory or legal rights.

Installation Information

TV	<input type="text"/>	Postcode	<input type="text"/>
Radio	<input type="text"/>	System PIN	<input type="text"/>